

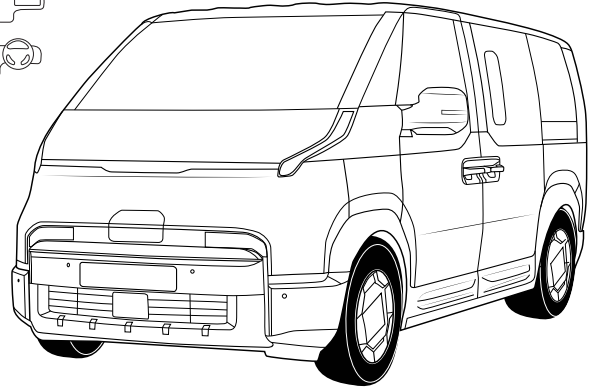

PV5

SW110ADE00P

SW110ADE10P

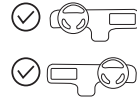
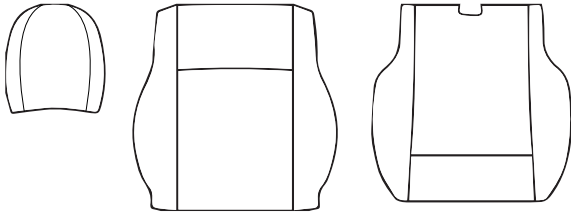

PV5 (SWk, MY25)  
All variants



P 2



P 2 & 8

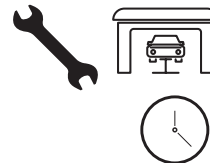

P 3 - 7

0,35 hours



Genuine Accessories  
developed by MOBIS

[www.mobisparts.eu](http://www.mobisparts.eu)



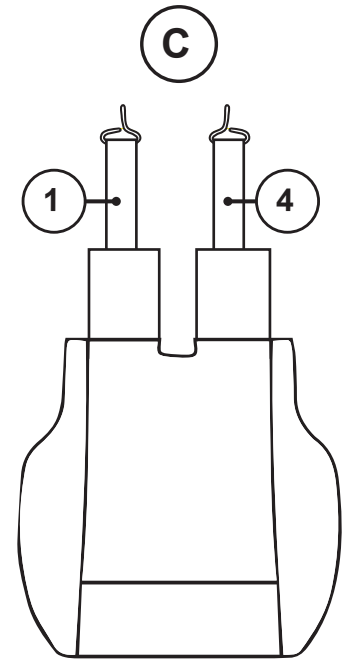
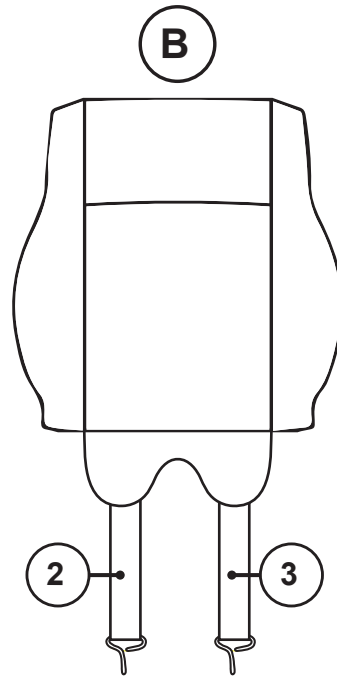
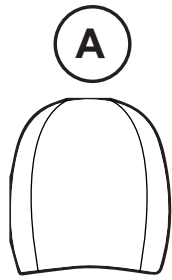

Other languages from  
[www.mobisparts.eu](http://www.mobisparts.eu)

(E / PT / I / NL / S / N / DK / FIN / CZ / PL / SK / RO / BG / EST / HR / HU / LAT / LIT / SER / SVN / UKR / ICE / GR / RUS)

**GB**

### Assembly guidelines:

The durability and the look of the seat covers are significant reliant to the quality of the assembly.

We expressly point out that assembly not carried out properly by a competent installer will result in cancellation of any right to damage compensation, in particular those arising by virtue of the product liability act.

Contents of these kits and their fitting manuals are subject to alteration without notice, please ensure that these instructions are read and fully understood before commencing installation.

**F**

### Instructions de montage:

La durabilité et l'apparence des housses de siège dépendent en grande partie de la qualité de l'assemblage.

Nous tenons à insister tout particulièrement sur le fait que si ce produit n'est pas correctement assemblé par un technicien compétent, aucun droit de compensation ne sera recevable en cas de dommages, notamment les droits en vertu de la loi concernant la responsabilité à l'égard des produits.

Le contenu de ce produit, ainsi que des guides de montage qui les accompagnent est sujet à modifications sans préavis; lisez attentivement ces instructions avant de procéder à l'installation.

**D**

### Montagehinweise:

Die Haltbarkeit und die Optik der Sitzbezüge sind maßgeblich von der Montagequalität abhängig.

Wir weisen ausdrücklich darauf hin, dass eine nicht fachgerecht durchgeführte Montage zum Erlöschen jeglicher Schadensersatzansprüche, insbesondere nach dem Produkthaftungsgesetz, führt.

Änderungen des Inhalts dieser Montagesätze und der dazugehörigen Einbauanleitungen bleiben vorbehalten. Bitte stellen Sie sicher, dass Sie diese Anleitungen vor Beginn der Montage gelesen und vollständig verstanden haben.



Fig. 1

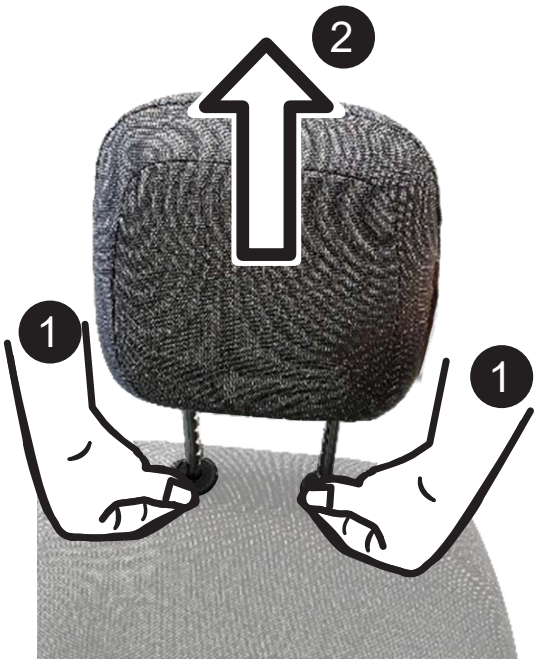

Fig. 2

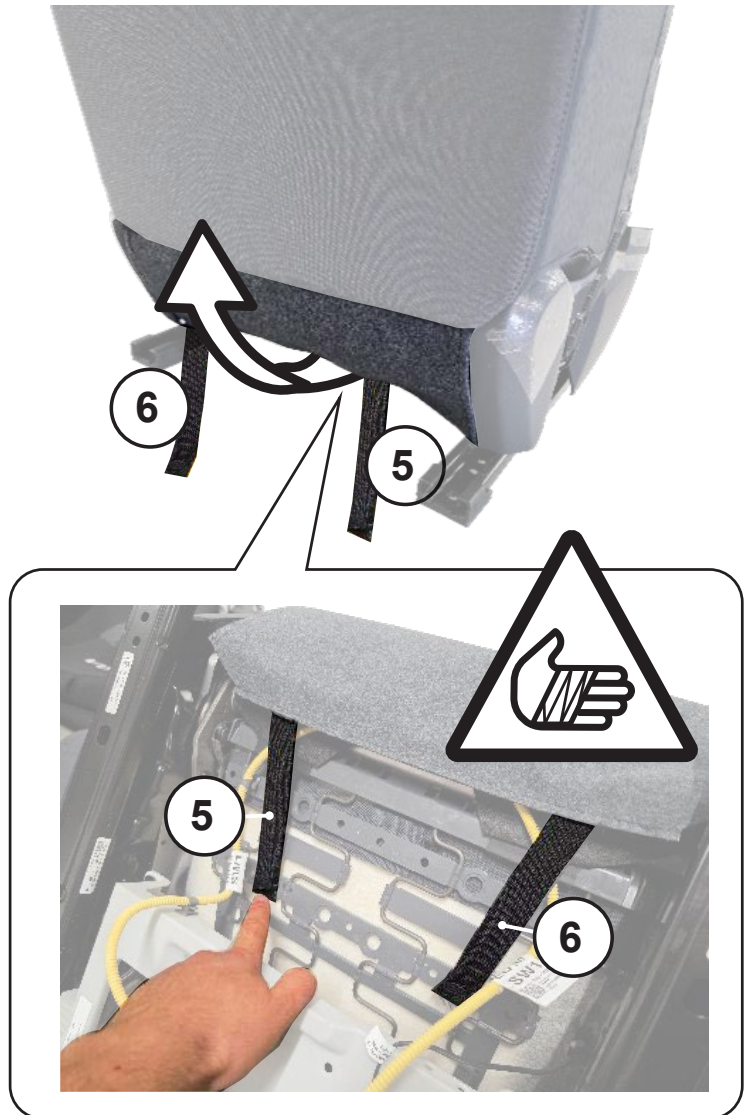

Fig. 3



Fig. 4

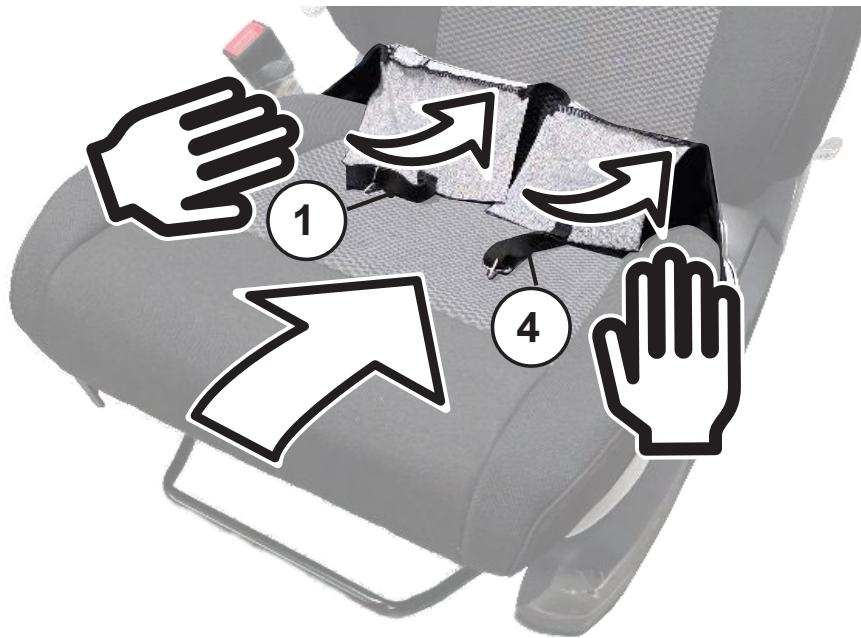

Fig. 5

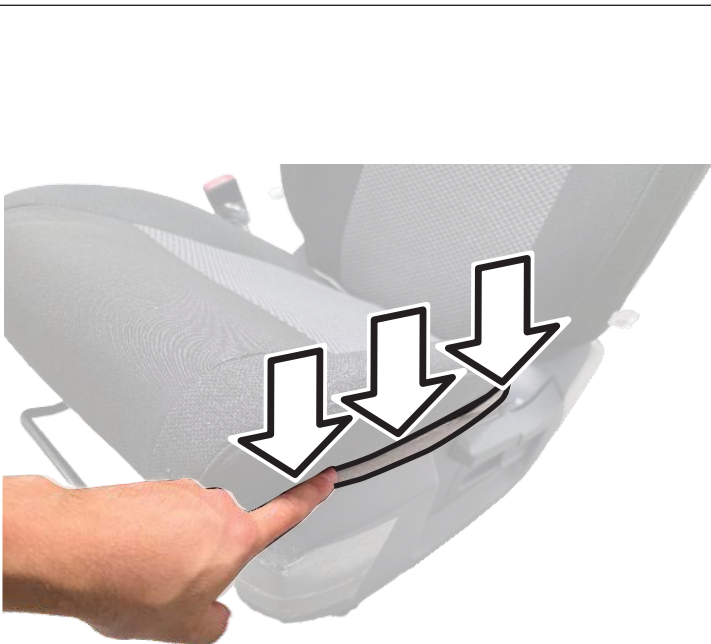

Fig. 6



Fig. 7

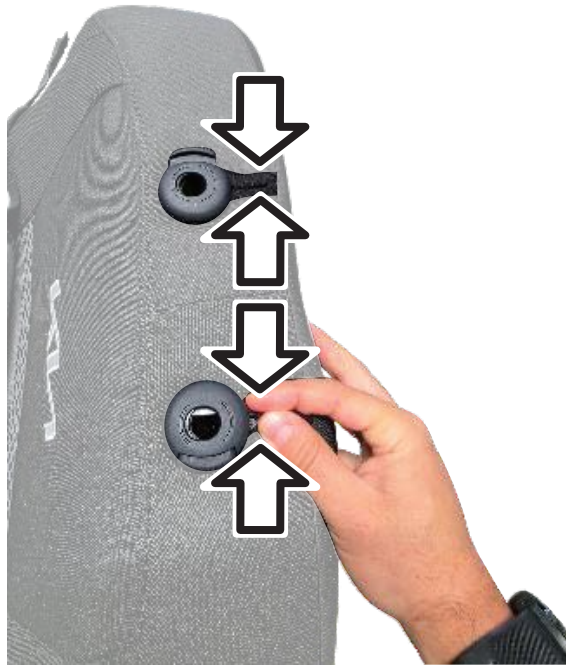

Fig. 8



Fig. 9

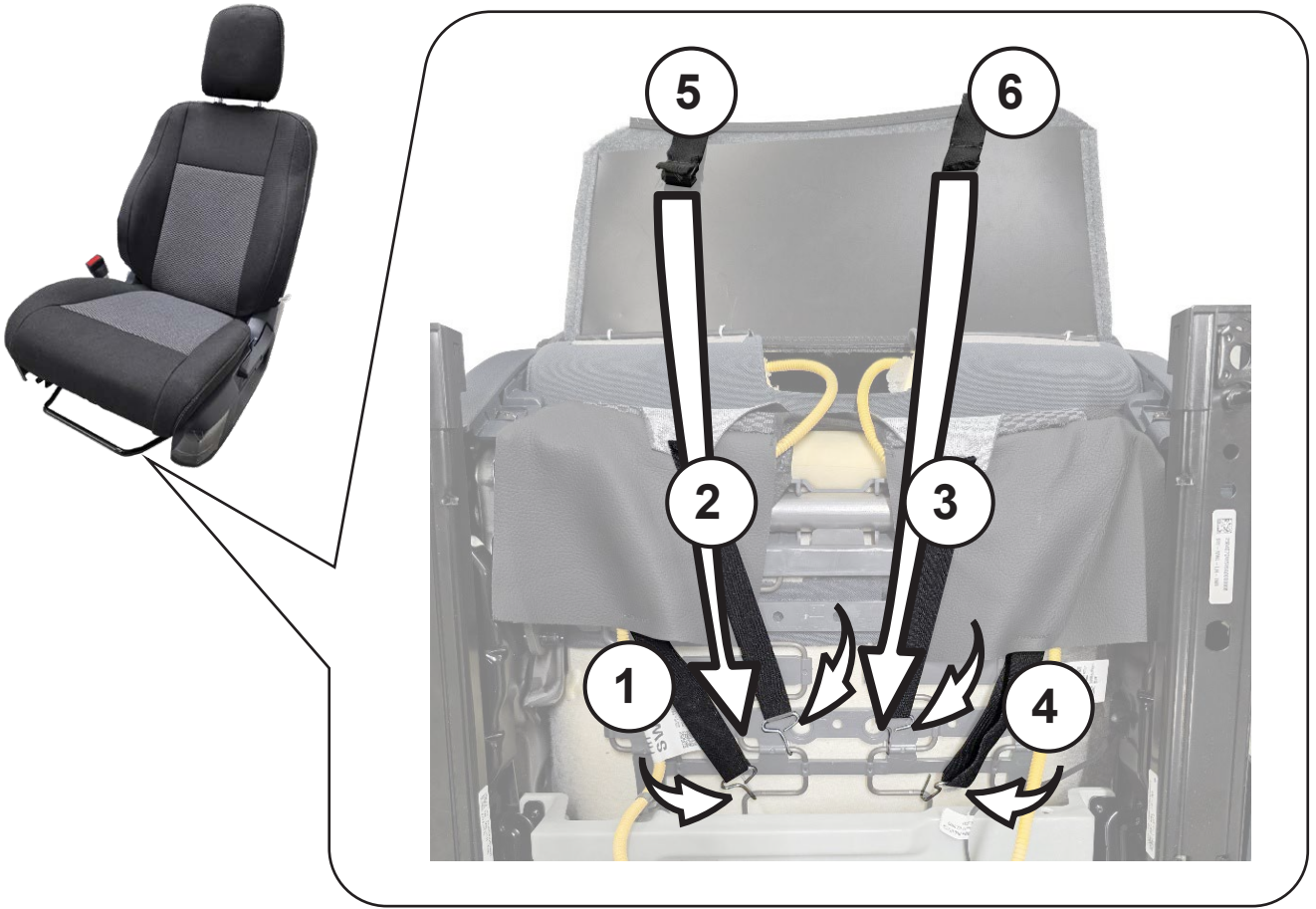

Fig. 10



Fig. 11

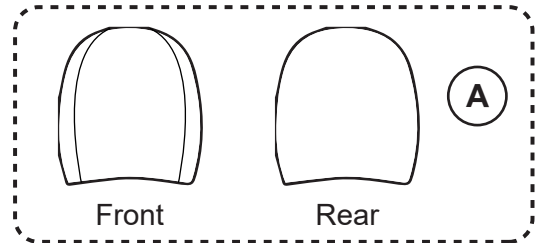

Fig. 12

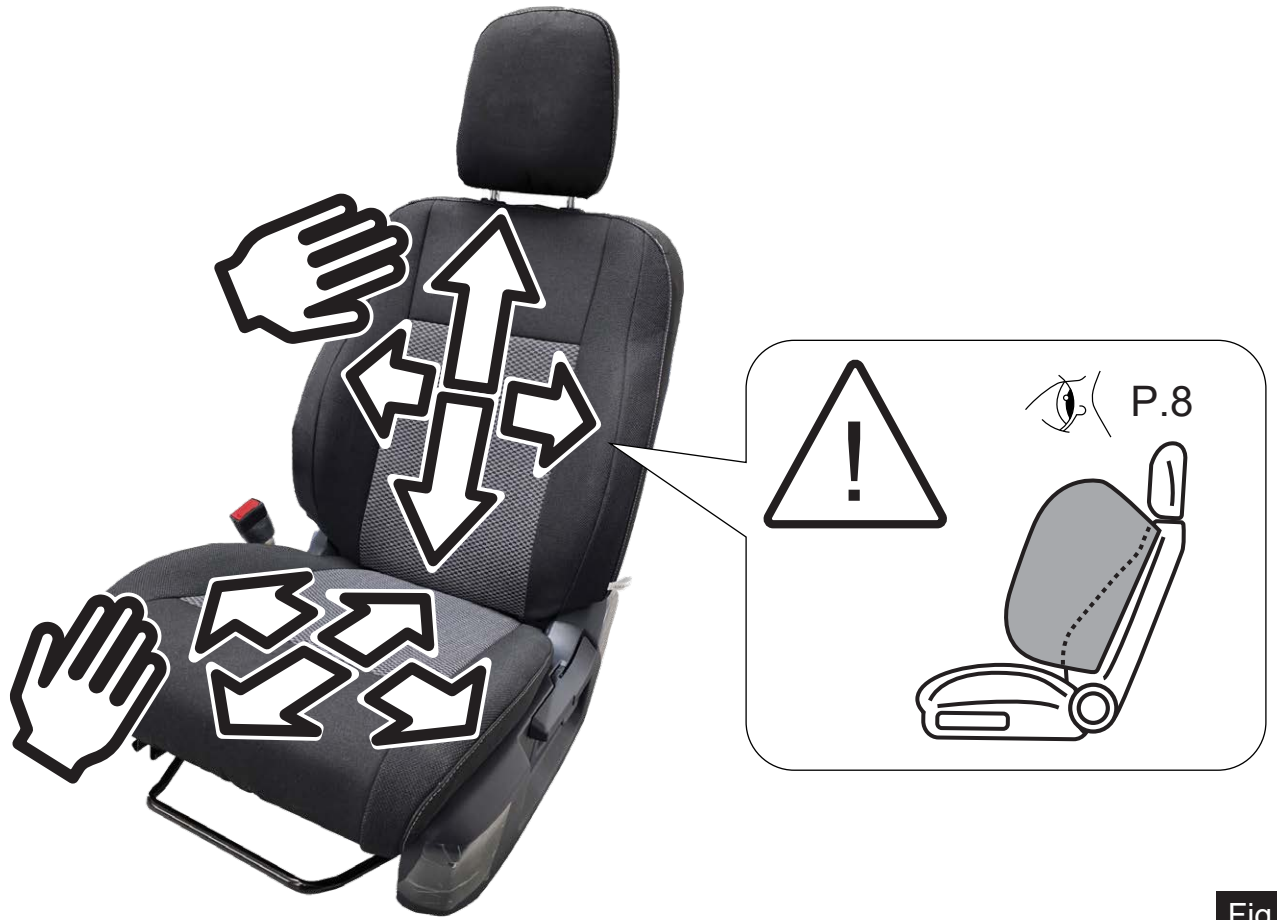
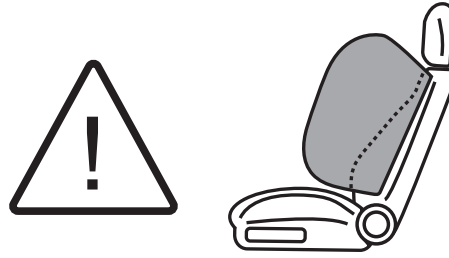

Fig. 13



Fig. 14



**GB**

### Safety guidelines for side airbag:

The seat cover has a tear seam for the side airbag. If the seat cover is not fitted correctly, the side airbag may not be able to deploy properly and won't offer its full protective effect in case of an accident. The „AIRBAG“-Label must be aligned to the outer side bolster of the respective seat backrest to the vehicle door.

The tear seam is subject to the obligation of documentary, necessary repairs must be executed by the manufacturer.

**F**

### Consignes de sécurité pour l'airbag latéral:

La housse de siège a une couture déchirée pour l'airbag latéral. Si la housse de siège n'est pas correctement installée, l'airbag latéral peut ne pas être en mesure de se déployer correctement et n'offrira pas tout son effet protecteur en cas d'accident. L'étiquette „AIRBAG“ doit être alignée sur le renfort latéral extérieur du dossier du siège respectif par rapport à la porte du véhicule.

La couture d'arrachage est soumise à l'obligation de documentaire, les réparations nécessaires doivent être effectuées par le fabricant.

**D**

### Sicherheitshinweise:

Der Bezug ist mit einer Sollreißnaht für den Seitenairbag ausgestattet. Bei falscher Montage könnte sich der Seitenairbag nicht richtig entfalten und nicht das vorgesehene Schutzpotential bei einem Unfall bieten. Die „AIRBAG“-Kennzeichnung muss zur jeweils äußeren Sitzwange der Sitzlehne zur Fahrzeuggestüre ausgerichtet sein.

Die Sollreißnaht unterliegt einer Dokumentationspflicht, notwendige Reparaturen dürfen nur vom Hersteller durchgeführt werden.